

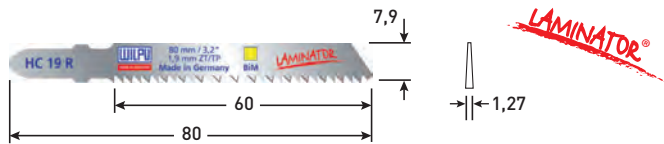

WILPU

Kijk voor meer informatie
op **www.rotec.tools**



HC 19 R bi

Toepassing: Speciaalblad van bi-metaal voor een splintervrije zaagsnede in gelamineerde plaat, zoals laminaat en Trespa®.

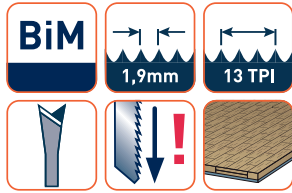

Wilpu	Bosch	Afmetingen (mm)	St./VE	Art.nr.	€ / VE
HC 19 R bi	T101 AIF	80x7,9x1,27	5	510.0021	13,84
HC 19 R bi	T101 AIF	80x7,9x1,27	25	510.0025	69,33

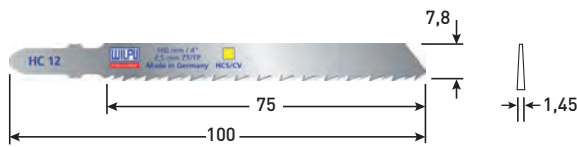

HC 12

Toepassing: CV-stalen zaagblad voor alle houtsoorten en kunststof tot 30 mm.

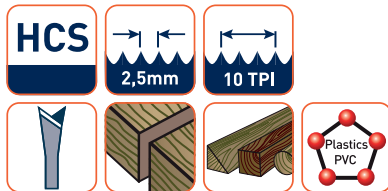

Wilpu	Bosch	Afmetingen (mm)	St./VE	Art.nr.	€ / VE
HC 12	T101B	100x7,8x1,45	5	510.0041	8,96
HC 12	T101B	100x7,8x1,45	25	510.0045	40,23

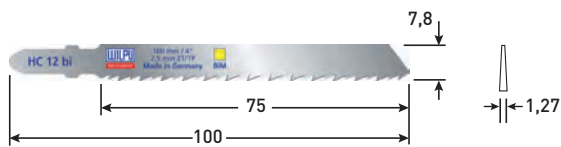

HC 12 bi

Toepassing: Bi-metalen zaagblad voor alle houtsoorten en kunststof tot 30 mm.

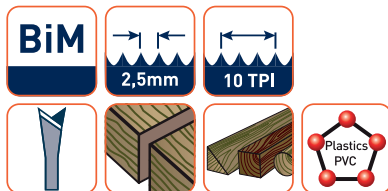

Wilpu	Bosch	Afmetingen (mm)	St./VE	Art.nr.	€ / VE
HC 12 bi	T101BF	100x7,8x1,27	5	510.0061	15,73

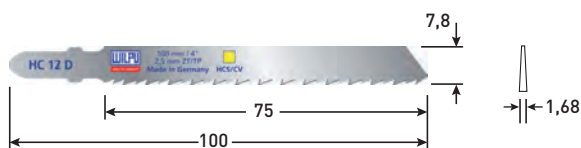

HC 12 D

Toepassing: Extra dik CV-stalen zaagblad. Zeer fijne zaagsnede in hard-en zacht hout, multiplex, spaanplaat en kunststof.

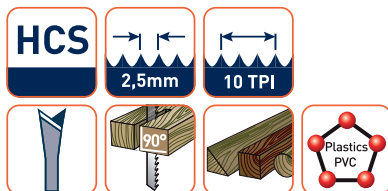

Wilpu	Bosch	Afmetingen (mm)	St./VE	Art.nr.	€ / VE
HC 12 D		100x7,8x1,68	5	510.0081	10,17

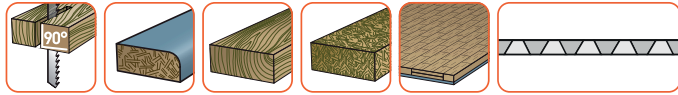
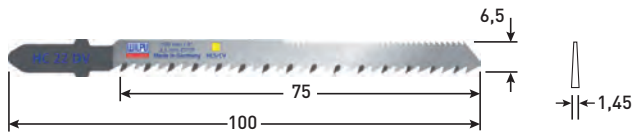

HC 22 DV

Toepassing: Conisch geslepen blad met geslepen tandenrij voor zuivere zaagsneden in zacht hout, spaanplaat, gelamineerd spaanplaat en multiplex (2,5-35mm).

Wilpu	Bosch	Afmetingen (mm)	St./VE	Art.nr.	€ / VE
HC 22 DV		100x6,5x1,45	5	510.0091	10,40

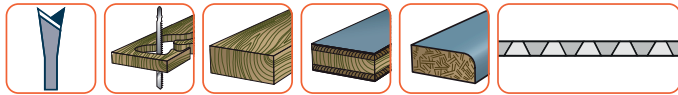
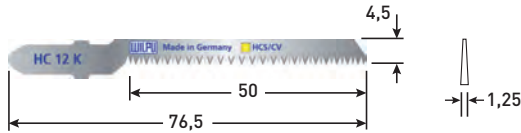

HC 12 K

Toepassing: CV-stalen zaagblad, speciaal voor het zagen van bochten in hout en kunststof.

Wilpu	Bosch	Afmetingen (mm)	St./VE	Art.nr.	€ / VE
HC 12 K	T101A0	76,5x4,5x1,25	5	510.0101	8,33

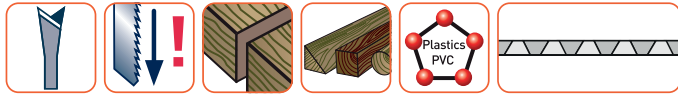
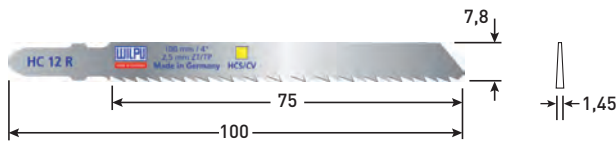

HC 12 R

Toepassing: CV-stalen zaagblad voor splintervrij zagen van gelamineerd hout en kunststof. Zeer zuivere zaagsnede.

Wilpu	Bosch	Afmetingen (mm)	St./VE	Art.nr.	€ / VE
HC 12 R	T101BR	100x7,8x1,45	5	510.0121	9,29

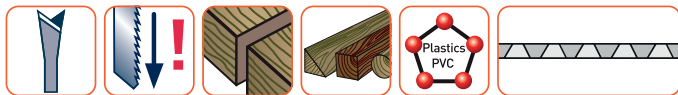
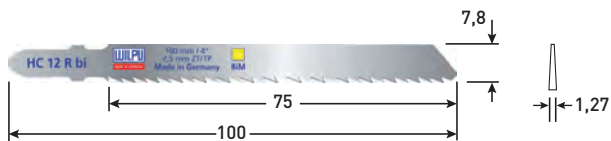

HC 12 R bi

Toepassing: Bi-metalen zaagblad voor splintervrij zagen van gelamineerd hout en kunststof. Zeer zuivere zaagsnede.

Wilpu	Bosch	Afmetingen (mm)	St./VE	Art.nr.	€ / VE
HC 12 R bi	T101BRF	100x7,8x1,27	5	510.0131	15,73

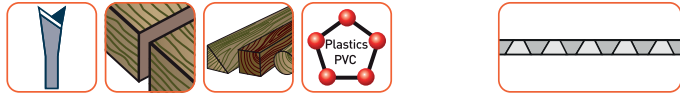
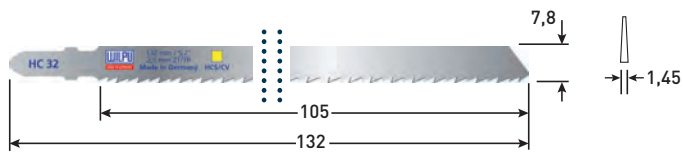

HC 32

Toepassing: Extra lang CV-stalen zaagblad voor alle houtsoorten en kunststof. Zeer zuivere zaagsnede.

Wilpu	Bosch	Afmetingen (mm)	St./VE	Art.nr.	€ / VE
HC 32		132x7,8x1,45	5	510.0141	13,64

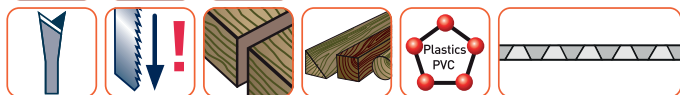
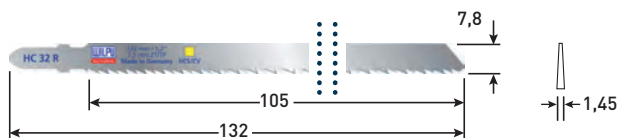

HC 32 R

Toepassing: Extra lang CV-stalen zaagblad voor alle houtsoorten en kunststof. Zeer zuivere zaagsnede.

Wilpu	Bosch	Afmetingen (mm)	St./VE	Art.nr.	€ / VE
HC 32 R	-	132x7,8x1,45	5	510.0161	13,64

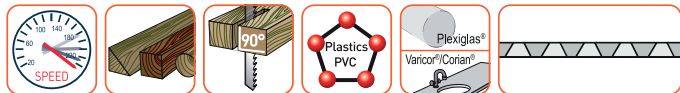
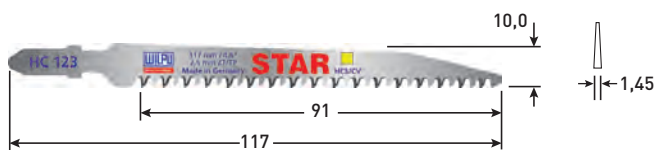

HC 123

Toepassing: 3-vlaks geslepen vertanding, conisch geslepen blad, zaagt 3x sneller dan een traditioneel zaagblad en tot 3x langere standtijd. Zeer zuivere zaagsnede in alle houtsoorten en kunststoffen van 10-60 mm.

Wilpu	Bosch	Afmetingen (mm)	St./VE	Art.nr.	€ / VE
HC 123	T234X	117x10x1,45	5	510.0151	11,81
HC 123	T234X	117x10x1,45	25	510.0155	58,90

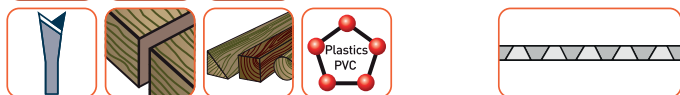
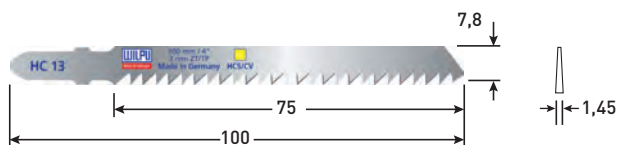

HC 13

Toepassing: CV-stalen zaagblad, voor hout tot 50 mm en kunststof.

Wilpu	Bosch	Afmetingen (mm)	St./VE	Art.nr.	€ / VE
HC 13		100x7,8x1,45	5	510.0181	8,08

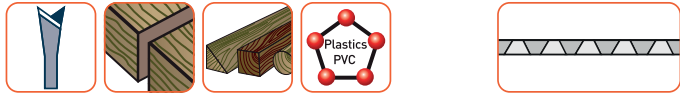
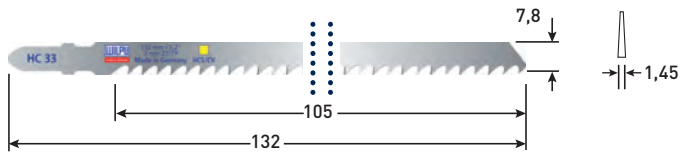

HC 33

Toepassing: Extra lang CV-stalen zaagblad voor alle houtsoorten en kunststof. Zeer snelle en zuivere zaagsnede.

Wilpu	Bosch	Afmetingen (mm)	St./VE	Art.nr.	€ / VE
HC 33	T301CD	132x7,8x1,45	5	510.0201	13,06

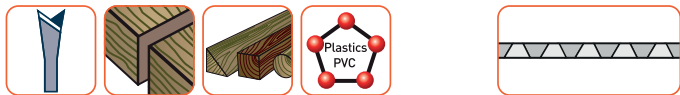
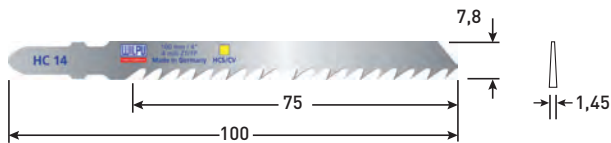

HC 14

Toepassing: CV-stalen zaagblad voor alle houtsoorten en kunststof. Zeer snelle en zuivere zaagsnede.

Wilpu	Bosch	Afmetingen (mm)	St./VE	Art.nr.	€ / VE
HC 14	T101D	100x7,8x1,45	5	510.0221	8,08
HC 14	T101D	100x7,8x1,45	25	510.0225	40,23

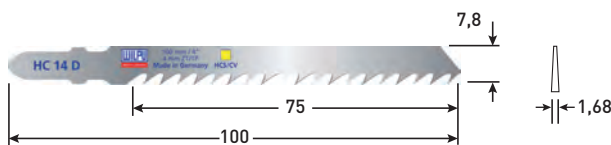

HC 14 D

Toepassing: Extra dik CV-stalen zaagblad voor zuivere en rechte zaagsnede in alle houtsoorten en kunststof.

Wilpu	Bosch	Afmetingen (mm)	St./VE	Art.nr.	€ / VE
HC 14 D	T101DP	100x7,8x1,68	5	510.0241	9,95

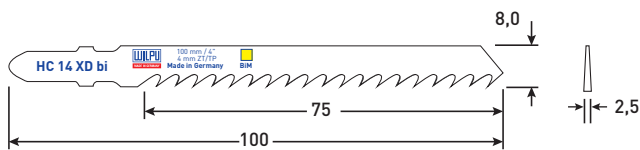

HC 14 XD bi

Toepassing: Extra dik Bi-metalen zaagblad voor rechte zaagsneden in hout tot 50mm, tevens geschikt voor bochtenwerk in dik materiaal.

Wilpu	Bosch	Afmetingen (mm)	St./VE	Art.nr.	€ / VE
HC14XD bi		100x8x2,5	2	510.0251	26,19

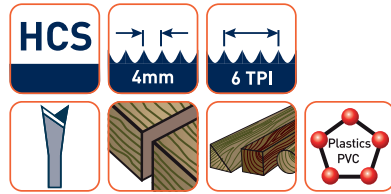
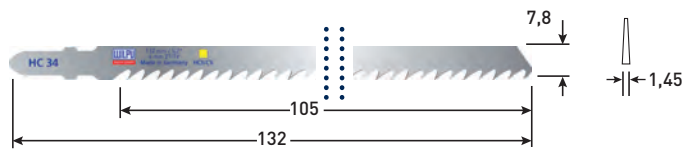

HC 34

Toepassing: Extra lang CV-stalen zaagblad voor alle houtsoorten en kunststof. Zuivere zaagsnede.

Wilpu	Bosch	Afmetingen (mm)	St./VE	Art.nr.	€ / VE
HC 34	T301DL	132x7,8x1,45	5	510.0261	13,06

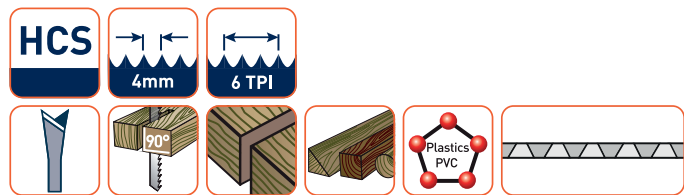
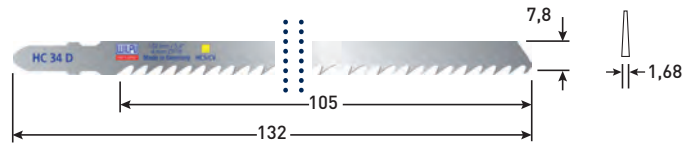

HC 34 D

Toepassing: Extra lang en dik CV-stalen zaagblad voor alle houtsoorten en kunststof.

Wilpu	Bosch	Afmetingen (mm)	St./VE	Art.nr.	€ / VE
HC 34 D		132x7,8x1,68	5	510.0281	15,00

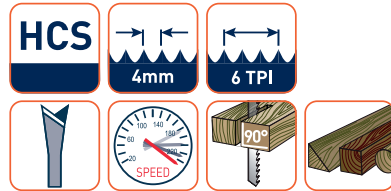
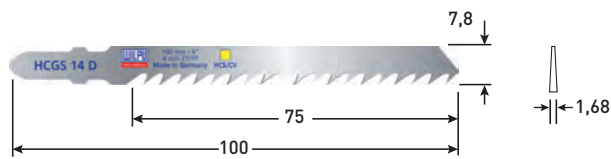

HCGS 14 D

Toepassing: CV-stalen zaagblad, dik en robuust blad voor een snelle rechte zaagsnede.

Wilpu	Bosch	Afmetingen (mm)	St./VE	Art.nr.	€ / VE
HCGS 14 D	-	100x7,8x1,68	5	510.0301	14,03

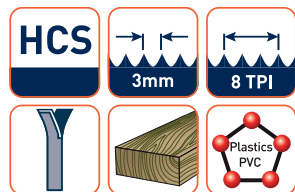
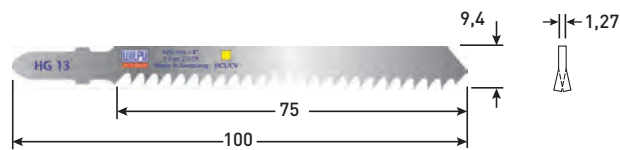

HG 13

Toepassing: CV-stalen zaagblad voor zacht hout en kunststof.

Wilpu	Bosch	Afmetingen (mm)	St./VE	Art.nr.	€ / VE
HG 13	T111C	100x9,4x1,27	5	510.0341	6,03

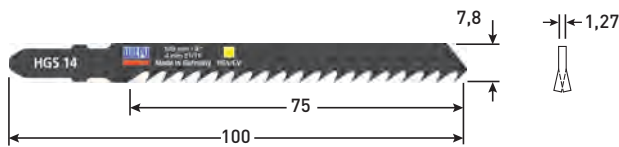

HGS 14

Toepassing: CV-stalen zaagblad, universeel blad voor alle houtsoorten.

Wilpu	Bosch	Afmetingen (mm)	St./VE	Art.nr.	€ / VE
HGS 14	T144D	100x7,8x1,27	5	510.0401	6,83
HGS 14	T144D	100x7,8x1,27	25	510.0405	31,90
HGS 14	T144D	100x7,8x1,27	100	510.0410	121,41

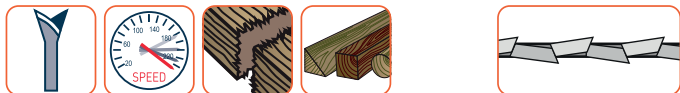
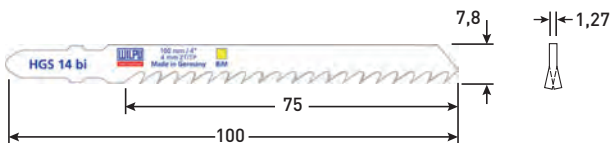

HGS 14 bi

Toepassing: Bi-metalen zaagblad, universeel blad voor alle houtsoorten.

Wilpu	Bosch	Afmetingen (mm)	St./VE	Art.nr.	€ / VE
HGS 14 bi	T144DF	100x7,8x1,27	5	510.0421	14,08

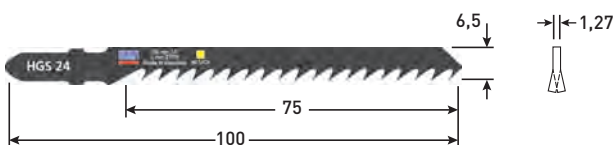

HGS 24

Toepassing: CV-stalen zaagblad, voor het zagen van bochten in alle houtsoorten.

Wilpu	Bosch	Afmetingen (mm)	St./VE	Art.nr.	€ / VE
HGS 24	T244D	100x6,5x1,27	5	510.0441	7,78

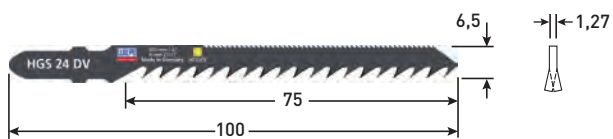

HGS 24 DV

Toepassing: CV-stalen zaagblad, speciaal voor het zagen van bochten in alle houtsoorten. Met rugvertanding.

Wilpu	Bosch	Afmetingen (mm)	St./VE	Art.nr.	€ / VE
HGS 24 DV	-	100x6,5x1,27	5	510.0461	9,85

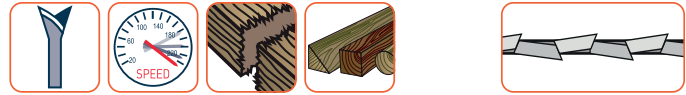
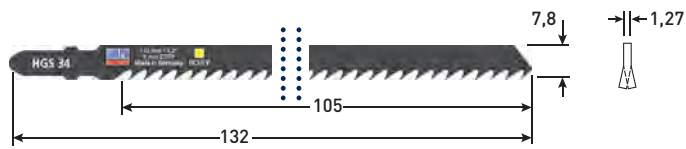

HGS 34

Toepassing: CV-stalen zaagblad, extra lang universeel blad voor alle houtsoorten.

Wilpu	Bosch	Afmetingen (mm)	St./VE	Art.nr.	€ / VE
HGS 34	T344D	132x7,8x1,27	5	510.0481	10,66

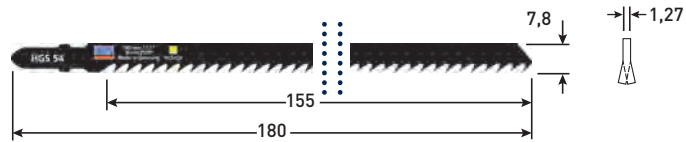

HGS 54

Toepassing: CV-stalen zaagblad, zeer lang en snel blad voor alle houtsoorten.

Wilpu	Bosch	Afmetingen (mm)	St./VE	Art.nr.	€ / VE
HGS 54	T744D	180x7,8x1,27	5	510.0501	17,93

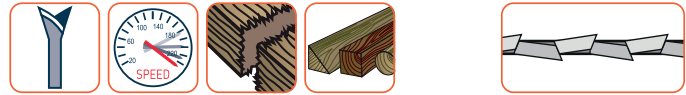
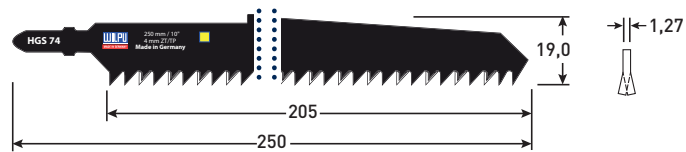

HGS 74

Toepassing: CV-stalen zaagblad, zeer lang en snel blad voor alle houtsoorten.

Wilpu	Bosch	Afmetingen (mm)	St./VE	Art.nr.	€ / VE
HGS 74	T1044DP	250x19x1,27	3	510.0508	16,56

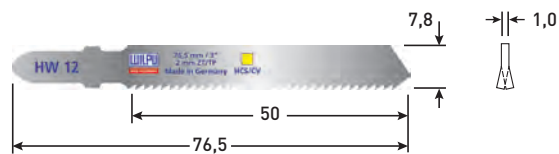

HW 12

Toepassing: CV-stalen zaagblad voor zacht hout en isolatiemateriaal.

Wilpu	Bosch	Afmetingen (mm)	St./VE	Art.nr.	€ / VE
HW 12	T119B	76,5x7,8x1,0	5	510.0521	5,52

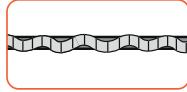
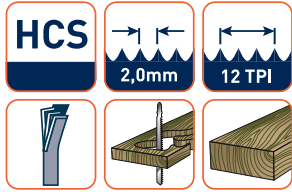
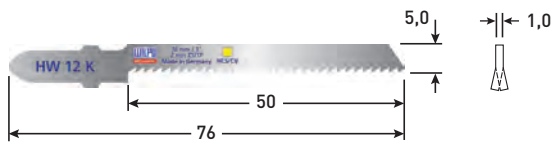

HW 12 K

Toepassing: CV-stalen zaagblad voor het zagen van bochten in zacht hout en isolatiemateriaal.

Wilpu	Bosch	Afmetingen (mm)	St./VE	Art.nr.	€ / VE
HW 12 K	T119B0	76,0x5,0x1,0	5	510.0541	6,52

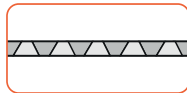
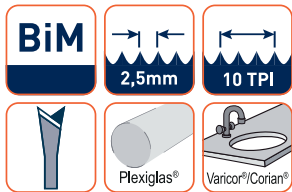
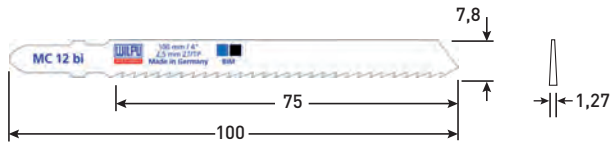

MC 12 bi

Toepassing: Bi-metalen zaagblad voor non-ferro metalen en aluminium.

Wilpu	Bosch	Afmetingen (mm)	St./VE	Art.nr.	€ / VE
MC 12 bi	T101A	100x7,8x1,27	5	510.0561	13,56

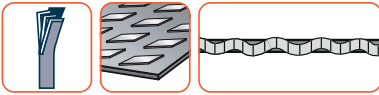
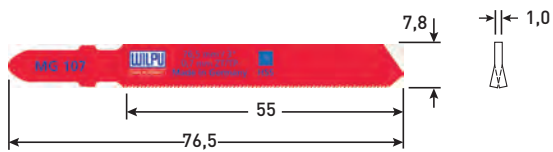

MG 107

Toepassing: HSS zaagblad voor zeer dun blik van 0,5 tot 1,5 mm.

Wilpu	Bosch	Afmetingen (mm)	St./VE	Art.nr.	€ / VE
MG 107	T118G	76,5x7,8x1,0	5	510.0581	8,94

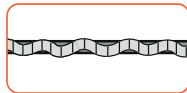
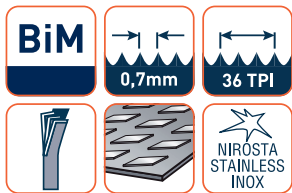
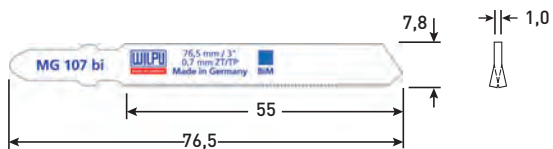

MG 107 bi

Toepassing: Bi-metalen zaagblad voor zeer dun blik en roestvaststaal van 0,5 tot 1,5 mm.

Wilpu	Bosch	Afmetingen (mm)	St./VE	Art.nr.	€ / VE
MG 107 bi	T118GFS	76,5x7,8x1,0	5	510.0601	10,89

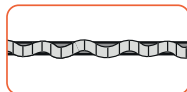
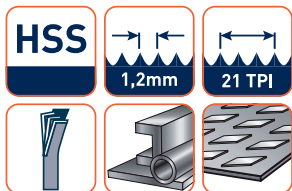

MG 11

Toepassing: HSS zaagblad voor staal en blik.

Wilpu	Bosch	Afmetingen (mm)	St./VE	Art.nr.	€ / VE
MG 11	T118A	76,5x7,8x1,0	5	510.0621	8,65
MG 11	T118A	76,5x7,8x1,0	25	510.0625	40,18

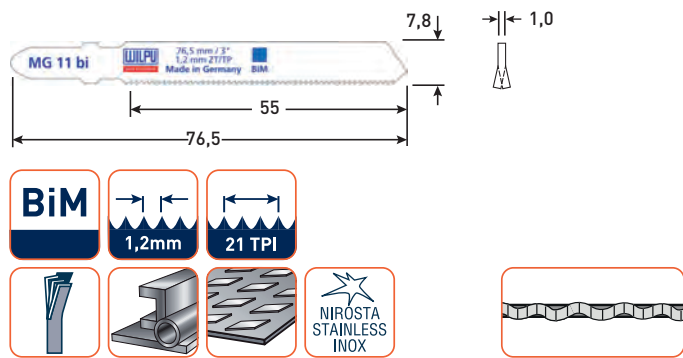

MG 11 bi

Toepassing: Bi-metalen zaagblad, flexibel blad voor zagen van bochten in dun metaal en roestvaststaal van 1,2 tot 2 mm.

Wilpu	Bosch	Afmetingen (mm)	St./VE	Art.nr.	€ / VE
MG 11 bi	T118AF	76,5x7,8x1,0	5	510.0641	10,52
MG 11 bi	T118AF	76,5x7,8x1,0	25	510.0645	48,86

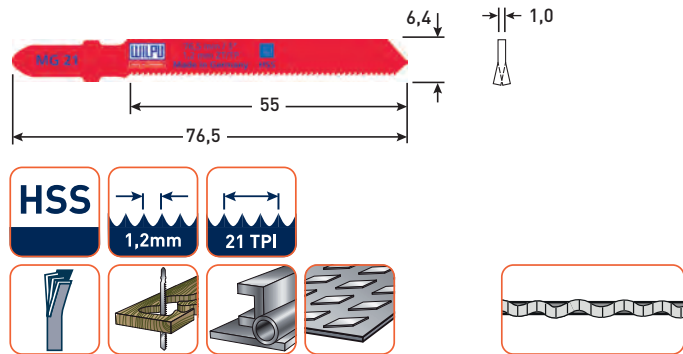

MG 21

Toepassing: HSS zaagblad voor zagen van bochten in staal en blik.

Wilpu	Bosch	Afmetingen (mm)	St./VE	Art.nr.	€ / VE
MG 21	T218A	76,5x6,4x1,0	5	510.0661	9,76

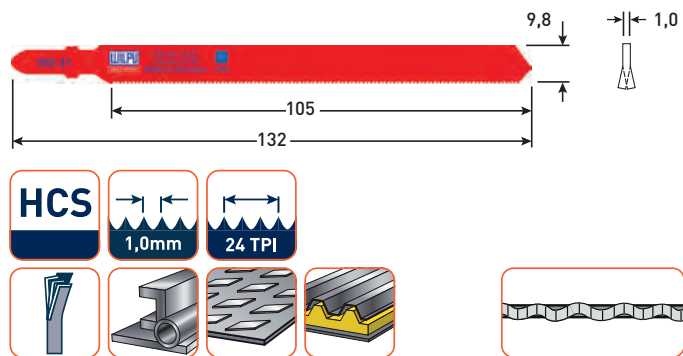

MG 31

Toepassing: Lang en flexibel CV-stalen zaagblad voor staal (1-3 mm), pijpen, profielen en sandwichmateriaal tot 80 mm dikte.

Wilpu	Bosch	Afmetingen (mm)	St./VE	Art.nr.	€ / VE
MG 31	T318A	132x9,8x1,0	5	510.0671	10,71

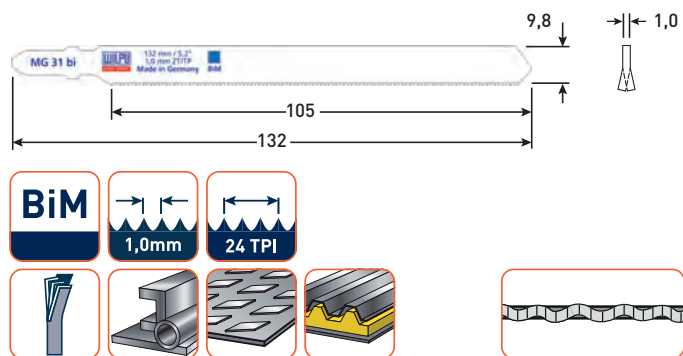

MG 31 bi

Toepassing: Lang en flexibel bi-metalen zaagblad voor staal (1-3 mm), pijpen, profielen en sandwichmateriaal tot 80 mm dikte.

Wilpu	Bosch	Afmetingen (mm)	St./VE	Art.nr.	€ / VE
MG 31 bi	T318AF	132x9,8x1,0	5	510.0681	16,75

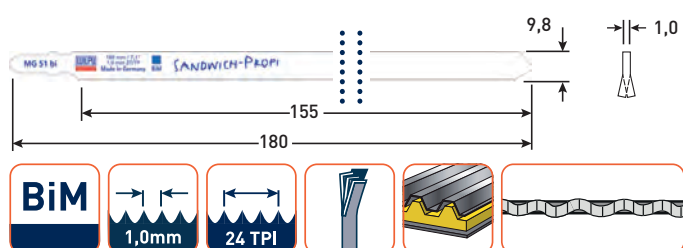

MG 51 bi

Toepassing: Bi-metalen zaagblad, zeer lang en flexibel blad voor sandwich-materialen.

Wilpu	Bosch	Afmetingen (mm)	St./VE	Art.nr.	€ / VE
MG 51 bi	T718BF	180x9,8x1,0	5	510.0701	22,70

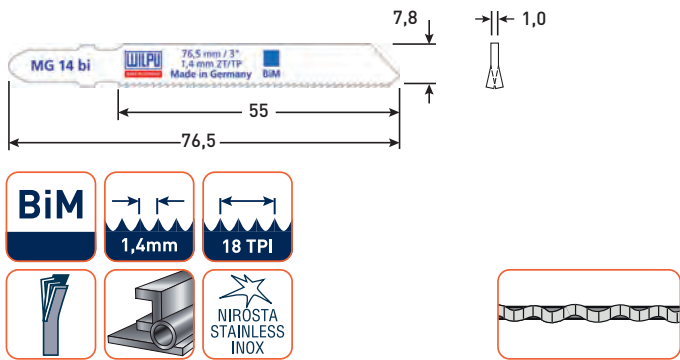

MG 14 bi

Toepassing: Bi-metalen zaagblad, flexibel blad voor staal en roestvaststaal van 1,5 tot 2,2 mm.

Wilpu	Bosch	Afmetingen (mm)	St./VE	Art.nr.	€ / VE
MG 14 bi	T118EF	76,5x7,8x1,0	5	510.0721	10,89

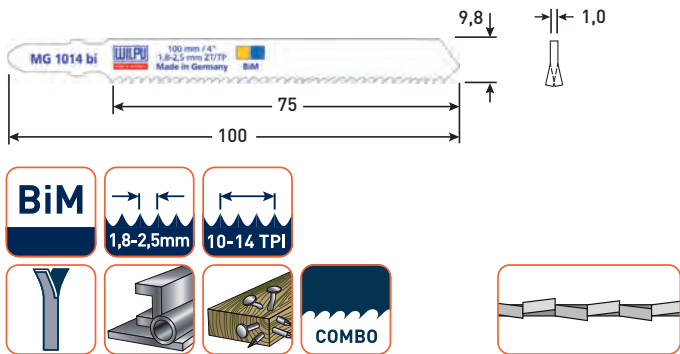

MG 1014 bi

Toepassing: Bi-metalen zaagblad met combi-vertanding voor staal en hout met spijkers of andere metaalresten.

Wilpu	Bosch	Afmetingen (mm)	St./VE	Art.nr.	€ / VE
MG 1014 bi	T111HF	100x9,8x1,0	5	510.0741	13,36

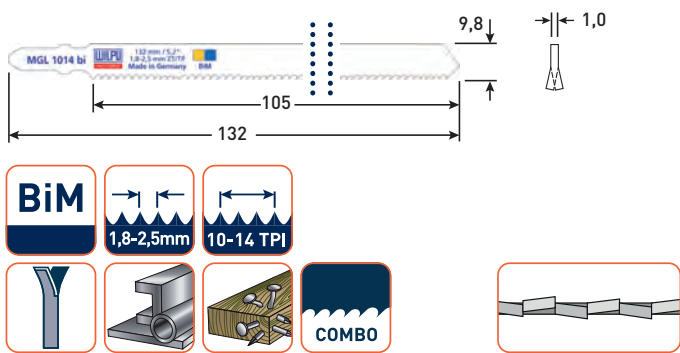

MGL 1014 bi

Toepassing: Bi-metalen zaagblad, extra lang blad met combi-vertanding voor staal en hout met spijkers of andere metaalresten.

Wilpu	Bosch	Afmetingen (mm)	St./VE	Art.nr.	€ / VE
MGL 1014 bi	T345XF	132x9,8x1,0	5	510.0761	19,31

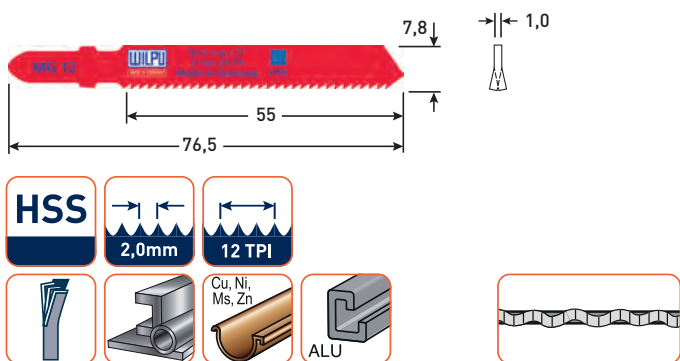

MG 12

Toepassing: HSS zaagblad, voor aluminium, non-ferro metalen, en staal van 2 tot 3 mm.

Wilpu	Bosch	Afmetingen (mm)	St./VE	Art.nr.	€ / VE
MG 12	T118B	76,5x7,8x1,0	5	510.0781	8,65

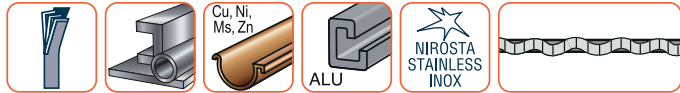
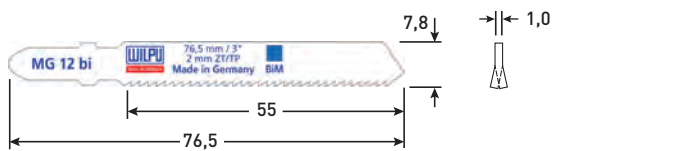

MG 12 bi
Toepassing: Bi-metalen zaagblad voor staal, aluminium, non-ferro metalen en roestvaststaal van 2 tot 3 mm.

Wilpu	Bosch	Afmetingen (mm)	St./VE	Art.nr.	€ / VE
MG 12 bi	T118BF	76,5x7,8x1,0	5	510.0801	10,89

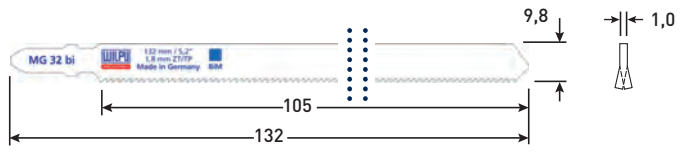

MG 32 bi
Toepassing: Bi-metalen zaagblad, extra lang en flexibel blad voor staal, sandwich-materialen en non-ferro metalen.

Wilpu	Bosch	Afmetingen (mm)	St./VE	Art.nr.	€ / VE
MG 32 bi	T318BF	132x9,8x1,0	5	510.0821	17,33

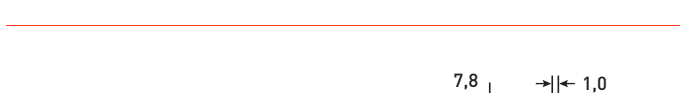
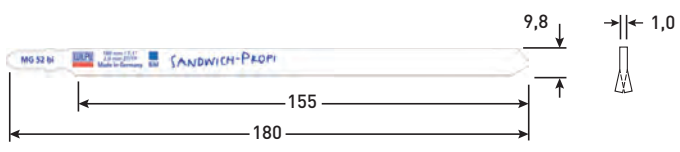

MG 52 bi
Uitvoering: Gefreesde en gegolfde tandenrij. Extra lang, flexibel zaagblad met lange standtijd.
Toepassing: Speciaal geschikt voor sandwichmaterialen van 2-120 mm dik.

Wilpu	Bosch	Afmetingen (mm)	St./VE	Art.nr.	€ / VE
MG 52 bi	T718BF	180x9,8x1,0	5	510.0831	22,57

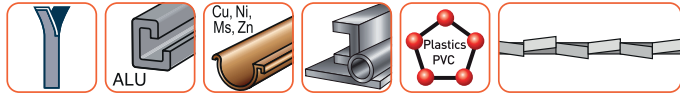
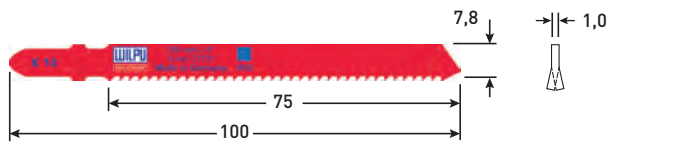

K 14
Toepassing: HSS zaagblad voor staal, non-ferro metalen, aluminium en kunststof.

Wilpu	Bosch	Afmetingen (mm)	St./VE	Art.nr.	€ / VE
K 14	T127D	100x7,8x1,0	5	510.0841	9,05

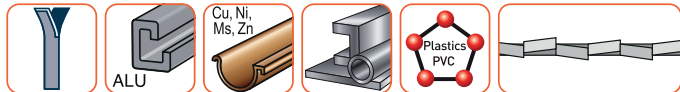
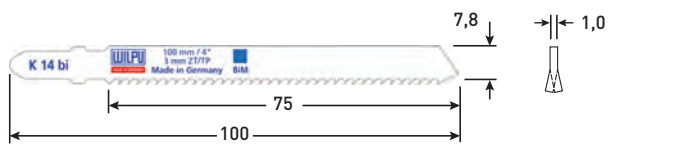

K 14 bi
Toepassing: Bi-metalen zaagblad. Flexibel blad voor staal, non-ferro metalen, aluminium en kunststof.

Wilpu	Bosch	Afmetingen (mm)	St./VE	Art.nr.	€ / VE
K 14 bi	T127DF	100x7,8x1,0	5	510.0861	11,70

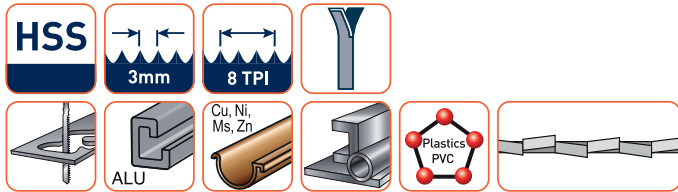
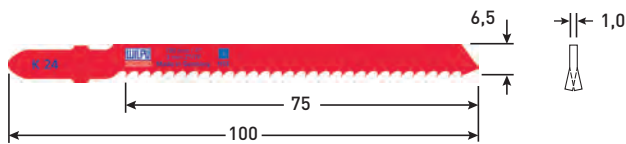

K 24

Toepassing: HSS zaagblad voor het zagen van bochten in staal, non-ferro metalen, aluminium en kunststof.

Wilpu	Bosch	Afmetingen (mm)	St./VE	Art.nr.	€ / VE
K 24	T227D	100x6,5x1,0	5	510.0881	11,16

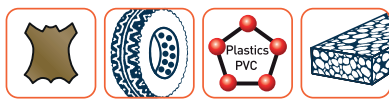
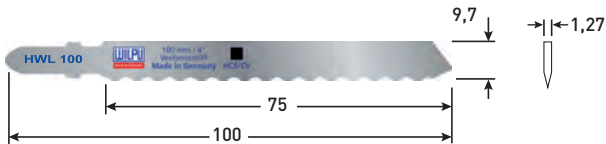

HWL 100

Toepassing: CV-stalen blad voor rubber, leder, plastic en isolatiematerialen.

Wilpu	Bosch	Afmetingen (mm)	St./VE	Art.nr.	€ / VE
HWL 100	T113A	100x9,7x1,27	5	510.0901	11,89

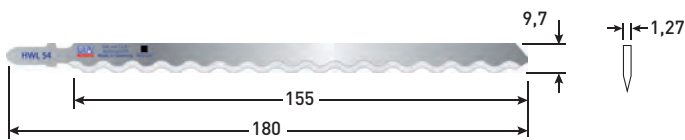

HWL 54

Toepassing: Extra lang decoupeermes met gegolfd geslepen blad. Voor het snijden van isolatiemateriaal, leer, rubber, papier, styropor en tapijt.

Wilpu	Bosch	Afmetingen (mm)	St./VE	Art.nr.	€ / VE
HWL 54	T313AW	100x9,7x1,27	5	510.0911	30,17

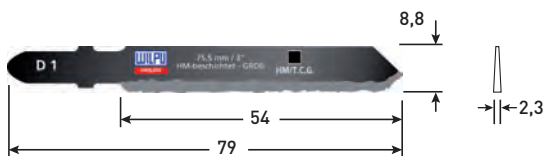

D 1

Toepassing: Hardmetaal gecoat zaagblad. Grofkorrelig. Voor glas, keramiek en glasvezelversterkt polyester.

Wilpu	Bosch	Afmetingen (mm)	St./VE	Art.nr.	€ / VE
D 1	T130Riff	79x8,8x2,3	3	510.0941	17,38

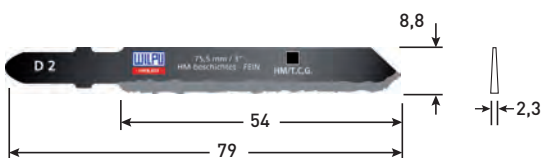

D 2

Toepassing: Hardmetaal gecoat zaagblad. Fijnkorrelig. Voor glas, keramiek en glasvezelversterkt polyester.

Wilpu	Bosch	Afmetingen (mm)	St./VE	Art.nr.	€ / VE
D 2	T150Riff	79x8,8x2,3	3	510.0961	17,38

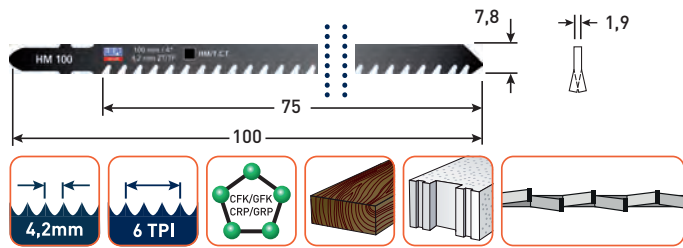

HM 100

Toepassing: Zaagblad met hardmetalen tanden voor glasvezelversterkt polyester, hardhout en gasbeton.

Wilpu	Bosch	Afmetingen (mm)	St./VE	Art.nr.	€ / VE
HM 100	T141HM	100x7,8x1,9	1	510.0981	16,76

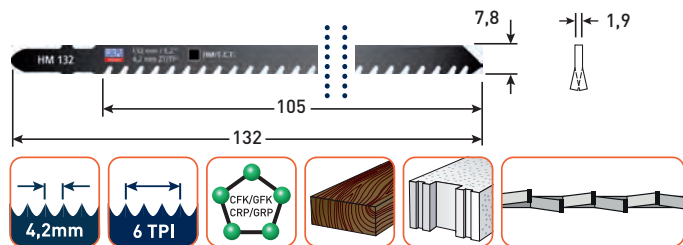

HM 132

Toepassing: Zaagblad met hardmetalen tanden voor glasvezelversterkt polyester, hardhout en gasbeton.

Wilpu	Bosch	Afmetingen (mm)	St./VE	Art.nr.	€ / VE
HM 132	T341HM	132x7,8x1,9	1	510.1001	20,97

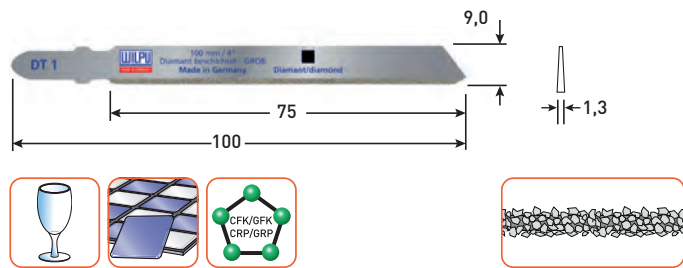

DT 1

Toepassing: Diamant gecoat zaagblad. Grof. Voor GFK, CFK, marmer, keramiek en glas.

Wilpu	Bosch	Afmetingen (mm)	St./VE	Art.nr.	€ / VE
DT 1	-	100x9x1,3	1	510.1021	108,09

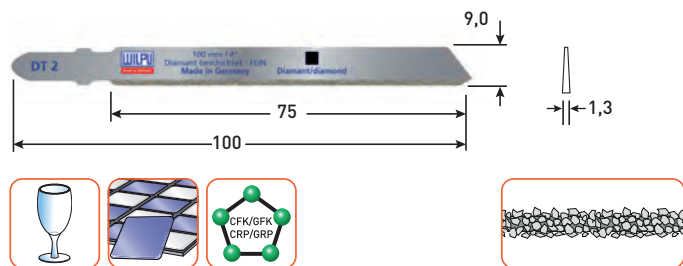

DT 2

Toepassing: Diamant gecoat zaagblad. Fijn. Voor GFK, CFK, marmer, keramiek en glas.

Wilpu	Bosch	Afmetingen (mm)	St./VE	Art.nr.	€ / VE
DT 2	-	100x9x1,3	1	510.1041	108,09

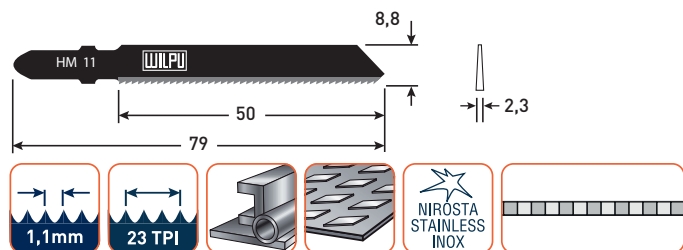

HM 11

Toepassing: Zaagblad met hardmetalen tanden voor staal, blik en roestvaststaal tot 2,5 mm.

Wilpu	Bosch	Afmetingen (mm)	St./VE	Art.nr.	€ / VE
HM 11	T118AHM	79x8,8x2,3	2	510.1081	30,49

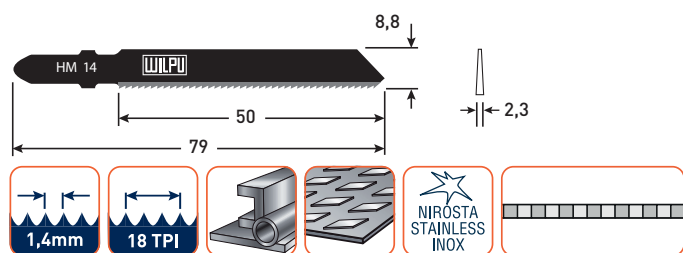

HM 14

Toepassing: Zaagblad met hardmetalen tanden voor staal, blik en roestvaststaal tot 2,5 mm.

Wilpu	Bosch	Afmetingen (mm)	St./VE	Art.nr.	€ / VE
HM 14	T118EHM	79x8,8x2,3	2	510.1101	28,63

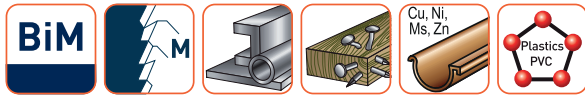
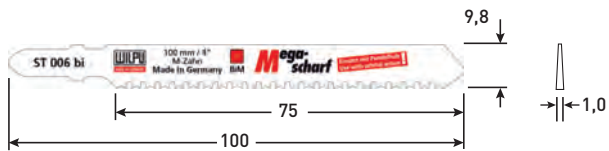

ST 006 bi

Toepassing: Bi-metalen speciaalzaagblad met gepatenteerde M-vertanding. Zaagt in beide richtingen. Zeer lange standtijd.

Wilpu	Bosch	Afmetingen (mm)	St./VE	Art.nr.	€ / VE
ST 006 bi	-	100x9,8x1,0	2	510.1122	15,28

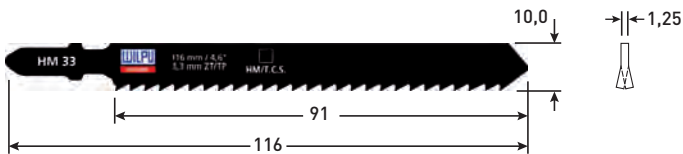

HM 33

Toepassing: Zaagblad voorzien van geslepen HM tanden. Geschikt voor het zagen van GFK/Epoxy, Varicor, Corian (<65 mm).

Wilpu	Bosch	Afmetingen (mm)	St./VE	Art.nr.	€ / VE
HM 33	T301CHM	116x10x1,25	2	510.1151	53,09



Sort. 2000

Wilpu	Inhoud	St./VE	Art.nr.	€ / VE
Sort. 2000	1x HC 12 1x HG 13 1x HGS 14 1x MG 11 1x MG 12	1	510.0921	8,33

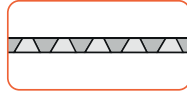
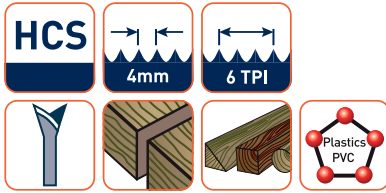
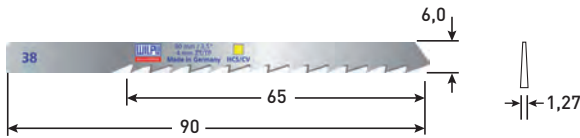

38

Toepassing: CV-stalen zaagblad voor alle houtsoorten en kunststof.

Wilpu	Fein	Afmetingen (mm)	St./VE	Art.nr.	€ / VE
38	635030 38 016	90x6,0x1,27	5	512.0061	9,51

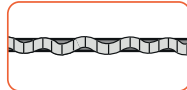
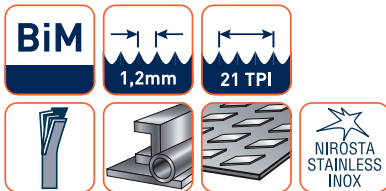
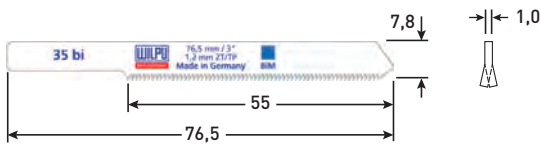

35 bi

Toepassing: Bi-metalen zaagblad. Flexibel blad voor staal en roestvaststaal van 1,2 tot 2 mm.

Wilpu	Fein	Afmetingen (mm)	St./VE	Art.nr.	€ / VE
35 bi		76,5x7,8x1,0	5	512.0141	12,44

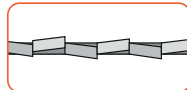
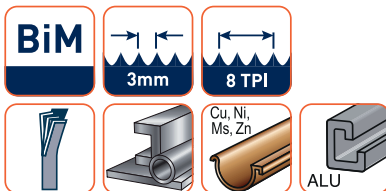
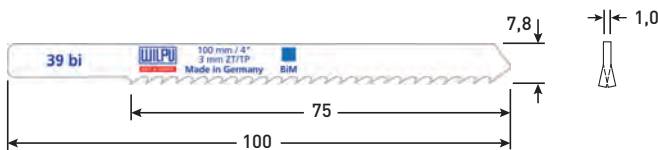

39 bi

Toepassing: Flexibel Bi-metalen zaagblad geschikt voor non-ferro metalen, aluminium, staal en kunststoffen tot 30 mm.

Wilpu	Fein	Afmetingen (mm)	St./VE	Art.nr.	€ / VE
39 bi	635030 39 010	100x7,8x1,0	5	512.0221	13,33

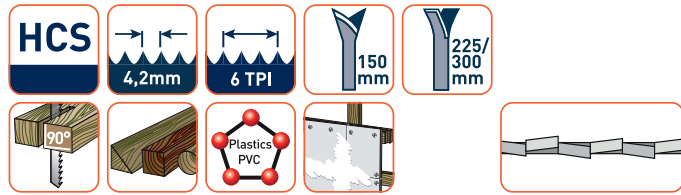

3021

Uitvoering: CV-stalen reciprozaagblad.

Toepassing: Blad voor alle houtsoorten en kunststof.

Wilpu	Bosch	Afmetingen (mm)	St./VE	Art.nr.	€ / VE
3021/150	S644D	150x19x1,27	5	515.0041	16,24
3021/225	-	225x19x1,27	5	515.0061	21,42
3021/300	S1344D	300x19x1,27	5	515.0081	25,29
3021/400	-	400x19x1,27	5	515.0091	33,71

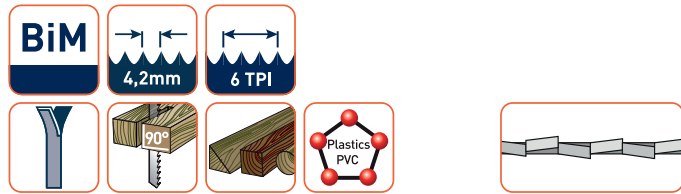
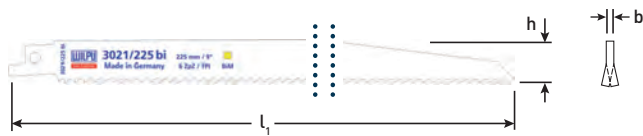

3021 bi

Uitvoering: Bi-metalen reciprozaagblad.

Toepassing: Blad voor alle houtsoorten, en kunststof.

Wilpu	Bosch	Afmetingen (mm)	St./VE	Art.nr.	€ / VE
3021/150 bi	S611DF	150x19x1,27	5	515.0101	25,85
3021/225 bi	S1111DF	225x19x1,27	5	515.0121	31,23
3021/300 bi	S1411DF	300x19x1,27	5	515.0141	40,27



3025

Uitvoering: CV-stalen reciprozaagblad.

Toepassing: Blad voor gipsplaten en hout.

Wilpu	Bosch	Afmetingen (mm)	St./VE	Art.nr.	€ / VE
3025/150	S628D	150x19x1,05	5	515.0161	13,77
3025/300	-	300x19x1,05	5	515.0171	21,13

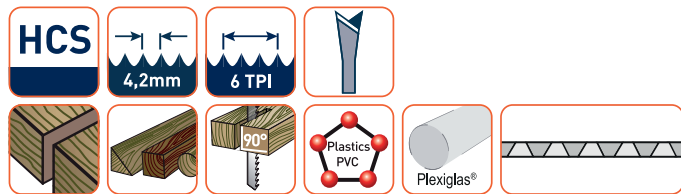

3023

Uitvoering: Uit Chroom-Vanadium conisch geslepen reciprozaagblad. Speciaal 3-vlaks geslepen tandenrij.

Toepassing: Extreem zuivere zaagsnede in alle houtsoorten.

Wilpu	Bosch	Afmetingen (mm)	St./VE	Art.nr.	€ / VE
3023/150	S2345X	150x19x1,27	5	515.0175	23,97
3023/240	S2345X	240x19x1,27	5	515.0176	38,16

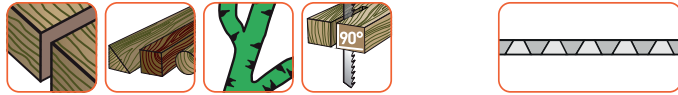
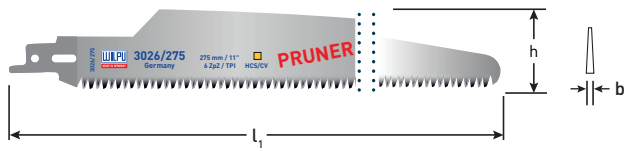

3026

Uitvoering: Uit Chroom-Vanadium conisch geslepen reciprozaagblad. Speciale 'Japantanden'.

Toepassing: Extreem zuivere zaagsnede in alle houtsoorten.

Wilpu	Bosch	Afmetingen (mm)	St./VE	Art.nr.	€ / VE
3026/275	-	275x34x1,6	2	515.0191	40,72



3029

Uitvoering: CV-stalen reciprozaagblad met inductief geharde tanden.

Toepassing: Speciaalblad voor levend hout.

Wilpu	Bosch	Afmetingen (mm)	St./VE	Art.nr.	€ / VE
3029/240	S1531L	240x19x1,27	5	515.0181	26,21
3029/240	S1531L	240x19x1,27	20	515.0182	99,68



3019

Uitvoering: CV-stalen reciprozaagblad.

Toepassing: Universeel blad voor alle houtsoorten.

Wilpu	Bosch	Afmetingen (mm)	St./VE	Art.nr.	€ / VE
3019/150	-	150x19x1,05	5	515.0201	14,73
3019/225	-	225x19x1,05	5	515.0221	18,73



3019 PC

Uitvoering: CV-stalen reciprozaagblad.

Toepassing: Universeel blad voor alle houtsoorten.

Wilpu	Bosch	Afmetingen (mm)	St./VE	Art.nr.	€ / VE
3019/225 PC	-	225x19x1,05	5	515.0225	22,39

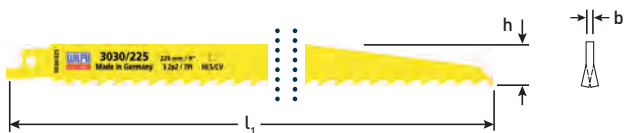

3030

Uitvoering: CV-stalen reciprozaagblad.

Toepassing: Grof vertand blad voor gewoon en levend hout.

Wilpu	Bosch	Afmetingen (mm)	St./VE	Art.nr.	€ / VE
3030/225	S1111K	225x19x1,27	5	515.0261	22,55
3030/300	S1617K	300x19x1,27	5	515.0281	27,22

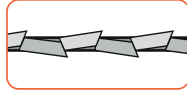
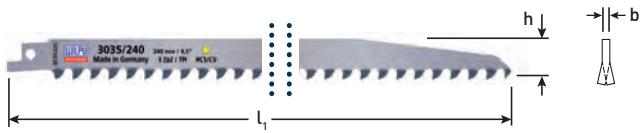

3035

Uitvoering: CV-stalen reciprozaagblad met inductief geharde tanden.

Toepassing: Zeer grof vertand blad voor agressief en snel zagen in nat hout.

Wilpu	Bosch	Afmetingen (mm)	St./VE	Art.nr.	€ / VE
3035/240	S1542K	240x19x1,27	5	515.0301	27,02

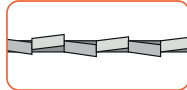
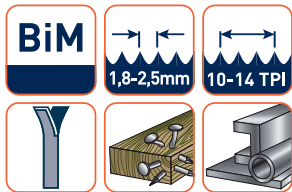

1014 C

Uitvoering: Bi-metalen reciprozaagblad met combi-vertanding.

Toepassing: Voor alle houtsoorten met metaal(-resten) vanaf 2,5 mm, en non-ferro metalen. Ook voor pallets.

Wilpu	Bosch	Afmetingen (mm)	St./VE	Art.nr.	€ / VE
1014C/150	S922VF	150x19x0,9	5	515.0321	22,41
1014C/200	-	200x19x0,9	5	515.0341	28,17
1014C/225	S1122VF	225x19x0,9	5	515.0361	31,05
1014C/280	S1222VF	280x19x0,9	5	515.0381	37,95

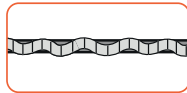
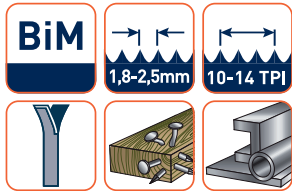

1014 CD

Uitvoering: Extra dik variabel vertand bi-metalen reciprozaagblad.

Toepassing: Voor rechte zaagsnede in alle houtsoorten met metaalresten. Staal vanaf 2,5 mm dikte. Veel gebruikt in de pallet-reparatie!

Wilpu	Bosch	Afmetingen (mm)	St./VE	Art.nr.	€ / VE
1014CD/150	S925VF	150x19x1,27	5	515.0391	25,25
1014CD/225	S1125VF	225x19x1,27	5	515.0411	32,85

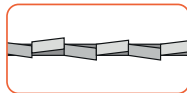
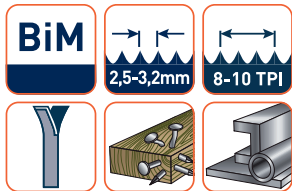
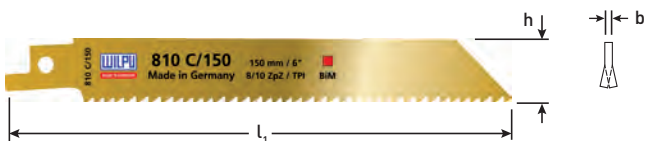

810 C

Uitvoering: Bi-metalen reciprozaagblad met combi-vertanding.

Toepassing: Voor alle houtsoorten met metaal(-resten) van 3,5 tot 5 mm, en non-ferro metalen. Speciaal voor pallets!

Wilpu	Bosch	Afmetingen (mm)	St./VE	Art.nr.	€ / VE
810C/150	-	150x19x0,9	5	515.0415	22,18
810C/225	-	225x19x0,9	5	515.0421	31,23

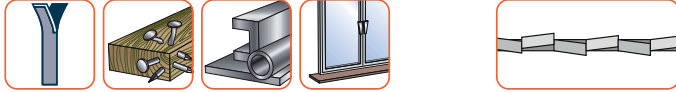
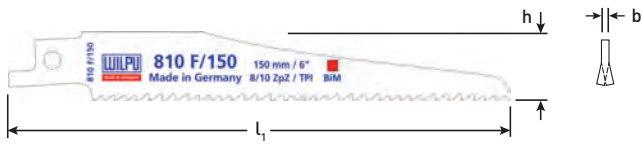

810 F

Uitvoering: Extra dik variabel vertand bi-metalen reciprozagblad.

Toepassing: Voor alle houtsoorten voorzien van metaalresten. Gezette tandenrij, zaagblad speciaal ontwikkeld voor demontage van kozijnen. Zaagt staal vanaf 3 mm dikte.

Wilpu	Bosch	Afmetingen (mm)	St./VE	Art.nr.	€ / VE
810F/150	-	150x19x1,27	5	515.0441	25,25

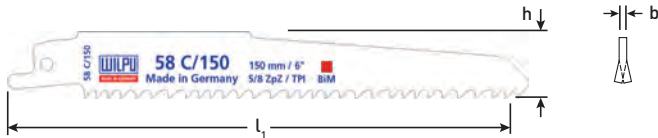

58 C

Uitvoering: Bi-metalen reciprozagblad, extra dik variabel vertand.

Toepassing: Voor alle houtsoorten met geringe metaalresten. Gezette tandenrij.

Wilpu	Bosch	Afmetingen (mm)	St./VE	Art.nr.	€ / VE
58C/150	S610VF	150x19x1,27	5	515.0451	25,25
58C/225	S1110VF	225x19x1,27	5	515.0461	32,85
58C/300	-	300x19x1,27	5	515.0471	43,16

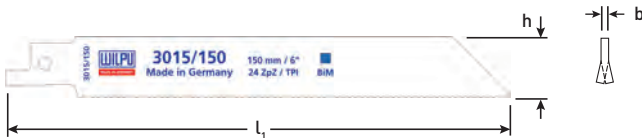

3015

Uitvoering: Bi-metalen reciprozagblad.

Toepassing: Zeer fijn vertand zaagblad voor blik tot 1,2 mm.

Wilpu	Bosch	Afmetingen (mm)	St./VE	Art.nr.	€ / VE
3015/150	S922AF	150x19x0,9	5	515.0581	20,26
3015/200	S1122AF	200x19x0,9	5	515.0601	25,46



3014

Uitvoering: Bi-metalen reciprozagblad.

Toepassing: Universeel zaagblad voor staal, roestvaststaal van 1,5 tot 2,5 mm.

Wilpu	Bosch	Afmetingen (mm)	St./VE	Art.nr.	€ / VE
3014/100	S522EF	100x19x0,9	5	515.0621	17,17
3014/150	S922EF	150x19x0,9	5	515.0641	20,63
3014/200	S1122EF	200x19x0,9	5	515.0661	24,43
3014/280	-	280x19x0,9	5	515.0681	31,64

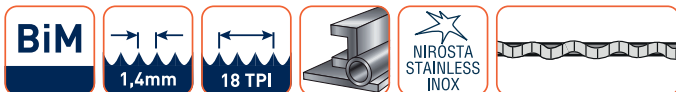

3014 PC

Uitvoering: Bi-metalen reciprozagblad met gefreesde en gezette tandenrij.

Toepassing: Flexibel universeelblad geschikt voor staal en RVS van 1,5-2,5 mm en non-ferro metalen. Gekromd blad voor sneller zagen en een langere standtijd.

Wilpu	Bosch	Afmetingen (mm)	St./VE	Art.nr.	€ / VE
3014/150 PC	-	150x19x0,9	5	515.0691	21,88
3014/225 PC	-	225x19x0,9	5	515.0695	29,19

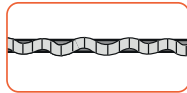

3013

Uitvoering: Bi-metalen reciprozaagblad.

Toepassing: Universeel zaagblad voor staal, RVS van 2,0 tot 3,5 mm.

Wilpu	Bosch	Afmetingen (mm)	St./VE	Art.nr.	€ / VE
3013/150	S922BF	150x19x0,9	5	515.0721	21,15
3013/200	S1122BF	200x19x0,9	5	515.0741	25,09
3013/250	-	250x19x0,9	5	515.0761	30,71

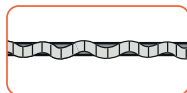

3013 PC

Uitvoering: Bi-metalen reciprozaagblad met gefreesde en gezette tandenrij.

Toepassing: Flexibel universeelblad geschikt voor staal en RVS van 2,0-3,0 mm en non-ferro metalen. Gekromd blad voor sneller zagen en een langere standtijd.

Wilpu	Bosch	Afmetingen (mm)	St./VE	Art.nr.	€ / VE
3013/150 PC	-	150x19x0,9	5	515.0771	21,72
3013/200 PC	-	225x19x0,9	5	515.0775	28,92

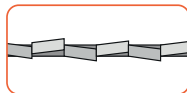
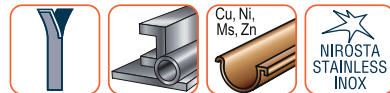

3018

Uitvoering: Bi-metalen reciprozaagblad.

Toepassing: Universeel zaagblad voor staal, roestvaststaal van 3,5 tot 5 mm.

Wilpu	Bosch	Afmetingen (mm)	St./VE	Art.nr.	€ / VE
3018/150	S922HF	150x19x0,9	5	515.0781	20,93
3018/200	S1122HF	200x19x0,9	5	515.0801	26,16
3018/280	-	280x19x0,9	5	515.0821	33,77

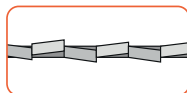

3016

Uitvoering: Bi-metalen reciprozaagblad voorzien van gefreesde en gezette tandenrij.

Toepassing: Zaagblad voorzien van groepsvertanding z.g.n. Twin-Cut, daardoor een langere standtijd en sneller zagen in metaal (>2,5mm) en hout met spijkers.

Wilpu	Bosch	Afmetingen (mm)	St./VE	Art.nr.	€ / VE
3016/150	-	150x19x0,9	5	515.0831	25,18
3016/225	S123XF	225x19x0,9	5	515.0833	32,74
3016/280	-	280x19x0,9	5	515.0835	39,95



3050

Uitvoering: Extreem sterk en robuust reciprozaagblad voor rechte zaagsnede in metaal dikker dan 3 mm. Ook geschikt voor hout en hout met metaalresten. Bijzonder geschikt voor sloop en reddingswerk.

Wilpu	Bosch	Afmetingen (mm)	St./VE	Art.nr.	€ / VE
3050/150	S920CF	150x22x1,57	3	515.0841	24,97
3050/225	S1120CF	225x22x1,57	3	515.0851	35,92
3050/300	-	300x22x1,57	3	515.0861	46,77



3055

Uitvoering: Extreem sterk en robuust reciprozaagblad voor zuivere zaagsneden in hout. Bijzonder geschikt voor sloop en reddingswerk.

Wilpu	Bosch	Afmetingen (mm)	St./VE	Art.nr.	€ / VE
3055/150	S610DF	150x22x1,57	3	515.0881	19,05
3055/225	S1110DF	225x22x1,57	3	515.0891	31,04
3055/300	-	300x22x1,57	3	515.0901	43,52

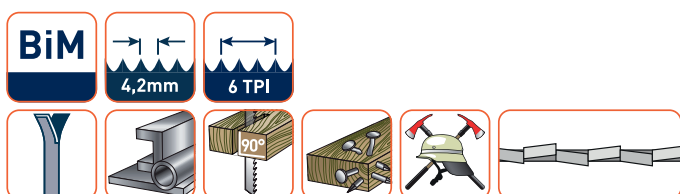

3060

Uitvoering: Extreem sterk en robuust reciprozaagblad voor zuivere zaagsneden in hout. Bijzonder geschikt voor sloop en reddingswerk.

Wilpu	Bosch	Afmetingen (mm)	St./VE	Art.nr.	€ / VE
3060/150	S930CF	150x22x1,57	3	515.0903	25,08
3060/225	S1130CF	225x22x1,57	3	515.0905	35,97
3060/300	S1230CF	300x22x1,57	3	515.0907	46,93

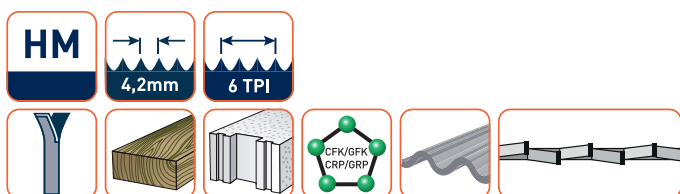

3040

Uitvoering: Reciprozaagblad met hardmetalen tanden.
Toepassing: Blad voor hardhout, gasbeton en glasvezelversterkt polyester.

Wilpu	Bosch	Afmetingen (mm)	St./VE	Art.nr.	€ / VE
3040/150HM	S641HM	150x19x1,3	1	515.0911	51,87
3040/300HM	-	300x19x1,3	1	515.0941	77,19

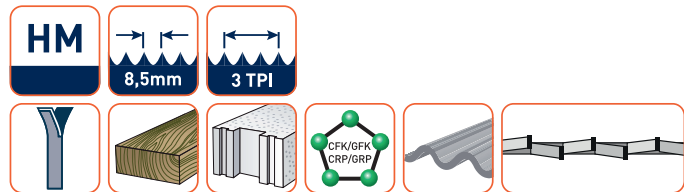

3041

Uitvoering: Reciprozaagblad met hardmetalen tanden.
Toepassing: Blad voor hardhout, gasbeton en glasvezelversterkt polyester.

Wilpu	Bosch	Afmetingen (mm)	St./VE	Art.nr.	€ / VE
3041/225 HM	S1141HM	225x19x1,3	1	515.0981	41,55
3041/300 HM	S1241HM	300x19x1,3	1	515.1001	48,41

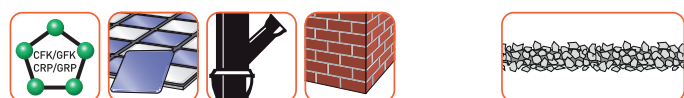
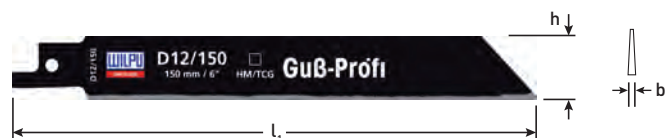

D12

Uitvoering: Hardmetaal gecoat reciproczaagblad.
Toepassing: Blad voor gietijzer, keramiek en glasvezelversterkt polyester.

Wilpu	Bosch	Afmetingen (mm)	St./VE	Art.nr.	€ / VE
D12/150	-	150x19x1,05	2	515.1041	23,04
D12/200	-	200x19x1,05	2	515.1061	29,98
D12/230	S1130Riff	230x19x1,05	2	515.1081	32,81

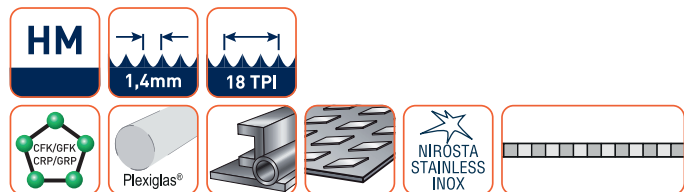
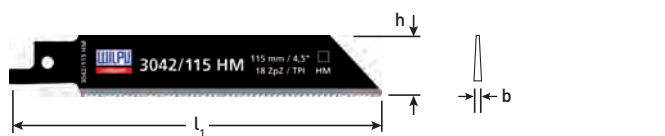

3042 HM

Uitvoering: Reciprozaagblad met geslepen hardmetalen tandenrij.
Toepassing: Speciaal ontwikkeld voor RVS-plaat, RVS-Profielen, glasfiber en carbonfiber.

Wilpu	Bosch	Afmetingen (mm)	St./VE	Art.nr.	€ / VE
3042/115	S518EHM	115x19x1,25	2	515.1091	34,85

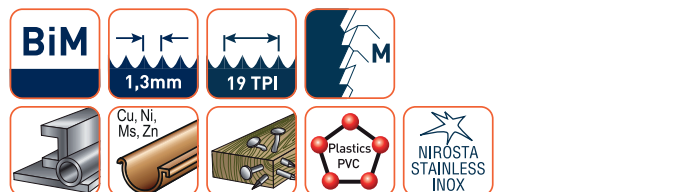

006

Uitvoering: Bi-metalen speciaalzaagblad met gepatenteerde M-vertanding.
Toepassing: Universeel zaagblad voor staal, non-ferro metaal, kunststof en hout met metaalresten.

Wilpu	Bosch	Afmetingen (mm)	St./VE	Art.nr.	€ / VE
006/150 bi	-	150x19x0,9	5	515.1101	35,51



007

Uitvoering: Bi-metalen speciaalzaagblad met gepatenteerde M-vertanding.
Toepassing: Universeel zaagblad voor staal, non-ferro metaal, kunststof en hout met metaalresten.

Wilpu	Bosch	Afmetingen (mm)	St./VE	Art.nr.	€ / VE
007/150 bi	-	150x19x0,9	5	515.1141	35,21
007/200 bi	-	200x19x0,9	5	515.1161	39,73



INOX

8,5mm

3 TPI

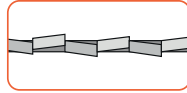

INOX

Uitvoering: Roestvrijstalen reciprozaagblad met gefreesde tandenrij.

Toepassing: Speciaal geschikt voor het zagen van bevroren voedsel. Zaagblad is volledig voedselveilig. Ook geschikt voor het zagen in hout.

Wilpu	Bosch	Afmetingen (mm)	St./VE	Art.nr.	€ / VE
INOX 300	S1211K	300x25x1,25	1	515.1201	22,51
INOX 400	-	400x25x1,25	1	515.1211	31,85



HCS



RWM

Toepassing: Tweezijdig gegolfd geslepen voor een snelle en zuivere zaagsnede in isolatiemateriaal. Voor het snel snijden van isolatiedekens zoals Rock-Wool, schuim (EPS,PUR) Polystyreen, Styropur, rubber, papier, en tapijt.

Wilpu	Bosch	Afmetingen (mm)	St./VE	Art.nr.	€ / VE
RWM 225	S1113AWP	225x19x1,27	2	515.1291	41,85
RWM 300	S1213AWP	300x19x1,27	2	515.1301	39,81

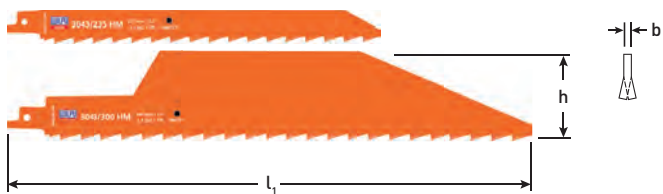

HM

10mm

2,5 TPI

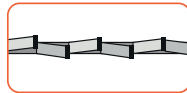

3043 HM

Uitvoering: Reciprozaagblad voorzien van HM-Tanden positief geslepen.

Toepassing: Ideaal voor snel zagen in gasbeton en rode baksteen.

Wilpu	Bosch	Afmetingen (mm)	St./VE	Art.nr.	€ / VE
3043/235 HM	S1543HM	215x20x1,2	1	515.1501	58,92
3043/300 HM	S1243HM	300x20x1,2	1	515.1511	68,53
3043/450 HM	-	450x50x1,2	1	515.1521	112,08
3043/300H HM	-	300x50x1,2	1	515.1521H	114,86

